



ZERAMEX[®] 

User guide

 swiss made

ZERAMEX®T – our dependable classic

- 4 ZERAMEX®T System overview
- 6 Treatment planning
- 8 Indications/contraindications
- 10 Tools and auxiliary parts/Dental tray setup
- 12 Sterilisation and instrument care
- 14 Surgery phase
- 20 Provisional restorations
- 21 Indirect impression taking
- 23 Prosthetic restorations
- 24 Cement-retained restorations
- 26 CAD/CAM base posts
- 32 Product range
- 36 General information

Dear Dental Specialist,

This guide provides you with basic information about ZERAMEX®T implants. Together with this product overview you will find relevant information with detailed and understandable explanations about

- Indications
- Pre-operative treatment planning
- Surgical procedures
- Prosthetic restoration

ZERAMEX®T – System Overview

The Tapered Design

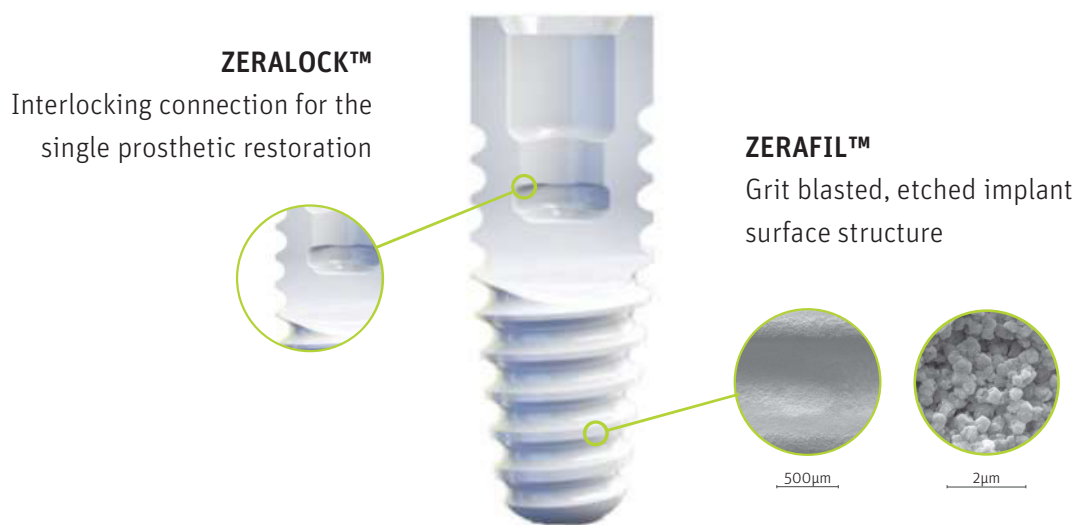

Biocompatible Drills

ZERADRILL™
Biocompatible reusable drills



Colour Coding and Sizes

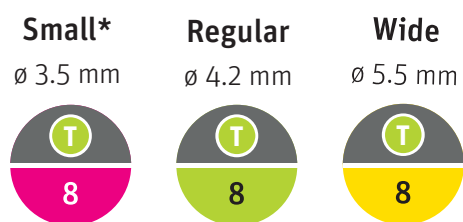

	Small*	Regular	Wide
ø platform	3.5 mm	4.2 mm	5.5 mm
ø intraossal	3.5 mm	4.2 mm	5.5 mm
Collar height	1.6 mm	1.6 mm	1.6 mm
8 mm			
10 mm			
12 mm			
14 mm			

intraossal

*For ZERAMEX®T small implants the indications are limited. Please refer to the notes on page 6.

	Small	Regular	Wide
Surgery	ZERAMEX® (T)apered Implants  T15308, T15310, T15312,	 T16308 T16310 T16312 T16314	 T17308 T17310 T17312
	ZERAMEX® (T)apered healing cap  T35400	 T36400	 T37400
Provisional restorations, soft tissue	ZERAMEX® (T)apered gingiva former  T35304	 T36304	 T37304
Impression taking	ZERLOCK™ Transfer open/closed tray  T35310, T35312	 T36310, T36312	 T36310, T36312
	ZERAMEX® (T)apered implant replica  T36320	 T36320	 T37320
Prosthetic restoration (final)	ZERALOCK™ Abutment straight  T15300	 T16300, T17300	 T16300, T17300
	ZERALOCK™ Abutment angular  T15315	 T16315	 T16315
	ZERAMEX® (T)apered CAD/CAM base  T16330	 T16330	 T17330
	ZERALOCK™ Locator®  P16202, P16203, P16205	 P16202, P16203, P16205	 P16202, P16203, P16205
	ZERAMEX® (T)apered Locator®  T15202, T15203	 T16202, T16203	 T16202, T16203

Treatment Planning in 5 Steps

Indications

ZERAMEX®T implants may be used for treatment indications as follows:

- Single tooth restoration*
- Bridge supports (max. 1-2 intermediate units)*
- Bar restorations*
- Bar and hybrid restoration combined with Locator®**

1 Preparation phase

Just like any other surgical intervention, a dental implantation requires the appropriate medical preparations. This includes a thorough examination of dental and physical health, with X-ray images and a detailed conversation with the patient for the purpose of recording the patient's medical history. Be sure to treat possible occurrences of gingival disease in advance. The available options and the objectives of the pending prosthetic restoration (item 5) should be discussed at the start as well.

In consideration of this baseline situation, prepare an individual treatment plan and write a protocol. Bone conditions that are hard to diagnose can be investigated with the help of a CT scan or cone beam computer tomography (CBCT). Bone structure and bone condition are decisive elements when planning the position and number of implants.

2 Implant selection

Take X-ray images to support decisions on implant length and diameter. Always select the greatest possible diameter. The vestibular wall thickness must be at least 1 mm, however, to preserve adequate blood circulation. If this is not possible, bone reconstruction will be necessary.

Limited indications

Use of the small ZERAMEX®T implant (ø 3.5 mm) is limited to the following: front teeth in lower jaw, lateral incisor teeth in upper jaw. Exception: Locator®**

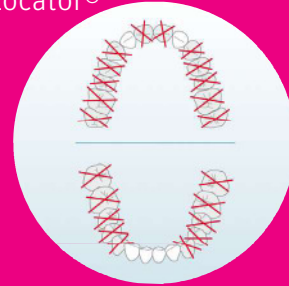

** Always use the implant with the largest possible diameter.

3 Bone preparation

The drill protocol on pages 13 to 15 must be observed without exception. As temperatures above 42 degrees Celsius increase the risk of changes in the bone structure and may thus affect bone integration, you must cool the implant area continuously during the procedure!

Important: Always fully insert the drill down to the prescribed marking. The implant itself is not self-cutting; always use a thread tap. If the cortical bone is very hard, you must use the ZERADRILL™ extension in an extra step. Please refer to the relevant drill protocol. Replace the drill after approximately 20 implants or when cutting performance decreases.

* ZERAMEX®T implants are components of a complete system, and they may only be used with the appropriate components. Dentalpoint AG cannot be made responsible for injuries resulting from the incorrect use of the components or use of inappropriate components.

4 Implant insertion

We recommend that you twist the implant into position by hand and do not exceed 15 revolutions per minute. The implant is **not** to be seated at bone level. The implant margin must remain readily accessible for you to cement the abutment precisely after the healing phase. Very good primary stability is important. Having seated the implant, cover it with a healing cap and then close the gingiva. In some instances, you can apply a gingiva former directly. The minimum healing time for the lower jaw is 3 months, and 6 months for the upper jaw.

DO NOT TURN TOO FAR!

The maximum torque for small implants is 35 N cm. Maximum torque for regular and wide implants is 45 N cm. Never exceed the maximum torque! The necessary torque depends on the bone quality (soft bone = lower torque) and implant length (short implant = lower torque) and must ALWAYS be less than the specified maximum torque.

Recommended torque: 20-30 N cm

5 Individual prosthetic restoration

You may customise zirconium oxide abutments with the use of appropriate diamond abrasive instruments and adequate cooling. This process requires high rotation rates and only slight pressure. You must cool with a spray aimed directly at the abrasive instrument and the immediate area. You must use diamond instruments with a fine abrasive grain (red ring, or grain finer than 50 µm).

Recommended drilling distances

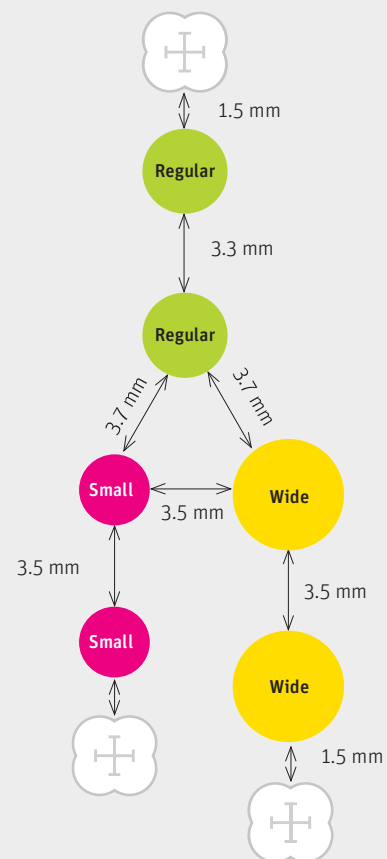

Indications

ZERAMEX®T implants may be used for treatment indications as follows:

- Single dental restoration
- Bridge pillars (max. 1-2 intermediate units)
- Bar restorations
- Bar and hybrid restorations combined with Locator®

Contraindications: system

- Overheated bone tissue
- Extreme implantation angle
- High degrees of divergence and convergence
- Inadequate distance between possible implants
- Length ratio of crown to implant 2:1
- Bridge over more than 1-2 intermediate units
- Pressure load during the healing phase
- Implant seated at bone level
- Oversized crowns
- Improperly cemented abutment (gap)

Contraindications: system and patient

- Inadequate bone anatomy
- Inadequate thickness of vestibular bone wall
- Unfavourable alignment of upper/lower jaw (e.g. very deep overbite)
- Bone growth not completed
- The patient should inform the dental specialist of regular medications, so that the dental medication can be selected accordingly.
- Tobacco, excessive alcohol consumption and drug use can jeopardise success of the restorative implantation. (Smoking is very critical during the healing phase.)
- Anticoagulant medication must be terminated by the primary care physician.
- It is very important for patients who take cortisone to inform the dental specialist of this medication. Cortisone can affect the immune system.
- Immune diseases, chemotherapy, osteoporosis, severe rheumatism
- Poor general health

Contraindications

Relative contraindications

- Diabetes mellitus
- Anticoagulant treatment
- Bruxism
- Parafunctional habits
- Unfavourable conditions of bone anatomy
- Untreated periodontitis
- Diseases of the temporomandibular joint
- Pregnancy
- Inadequate oral hygiene
- Fixed dental restoration between implant and natural tooth
- Crown attachment, free end bridge

General information

This guide does not replace professional training in dental implantology. Successful implantation is dependent on many factors.

Collaboration between the dentist, the dental laboratory and the patient, as well as respect for the restorative intervention are of the highest priority. Dental implantation treatment may only be performed by trained oral and maxillofacial surgeons, oral surgeons, and dentists.

ZERAMEX[®]T – Tools

Rose drill
 ø 2 mm
 T35601









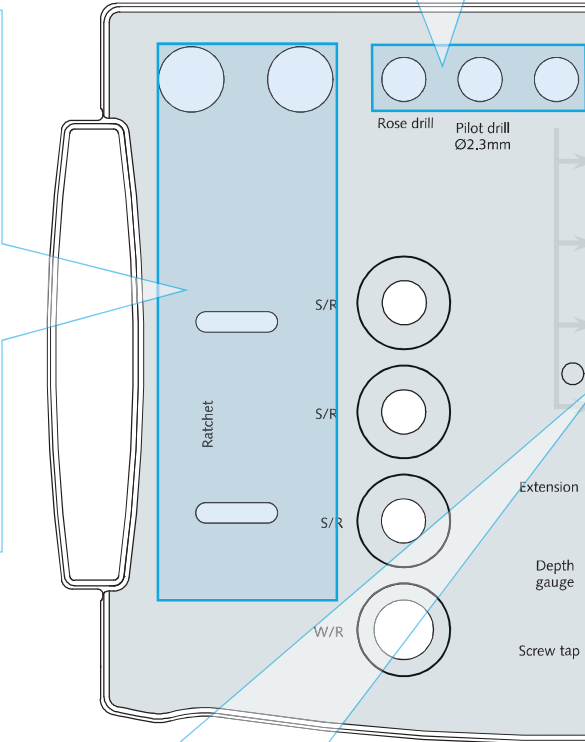

Adapter units
 T48936 T48937



Surgical ratchet
 T48935

ZERADRILL™		
<p>S8 (8 mm) T35608</p> 	<p>R8 (8 mm) T36608</p> 	<p>W8 (8 mm) T37608</p> 
<p>S10 (10 mm) T35610</p> 	<p>R10 (10 mm) T36610</p> 	<p>W10 (10 mm) T37610</p> 
<p>S12 (12 mm) T35612</p> 	<p>R12 (12 mm) T36612</p> 	<p>W12 (12 mm) T37612</p> 
<p>S14 (14 mm) T35614</p> 	<p>R14 (14 mm) T36614</p> 	

ZERADRILL™

Pilot ø 2.3 mm

T35602



ZERAMEX®T

Depth gauge

T38650

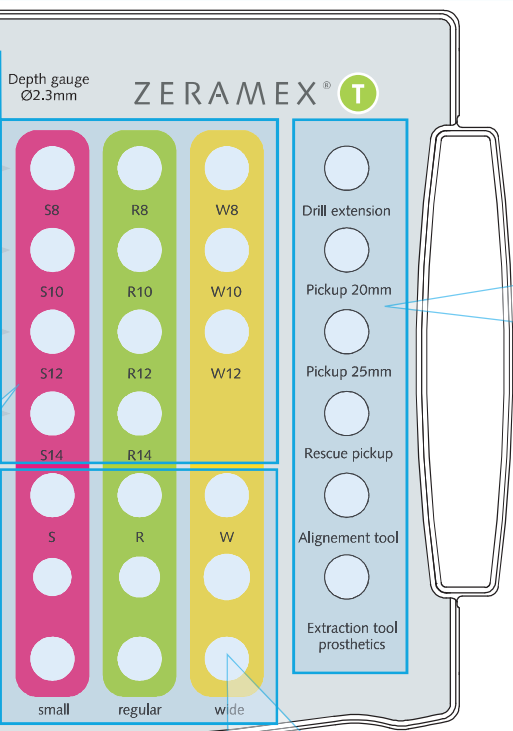

Drill extension

T38630



ZERAMEX®

Pickups

20 mm

T38620



25 mm

T38625



Rescue pickup

T38622



ZERAMEX®T
ZERALOCK™

Prosthetic instruments
Alignment aid

T38626



Insertion and extraction
aid

T38635



ZERADRILL™ Extension

small

T35622



regular

T36622



wide

T37622



ZERAMEX®T

Depth gauge

T38650



ZERATAP™

small ø 3.5 mm

T35620



regular ø 4.2 mm

T36620



wide ø 5.5 mm

T37620



Guidelines for Sterilisation and Instrument Care in accordance with EN ISO 17664

Reprocessing and preparing medical devices/ General requirements

Refer to the legal regulations and guidelines which are valid for medical office practices and hospitals in your country. This applies in particular to specifications for the effective denaturation of prions. Treatment always involves a risk of contamination and infection. Take preventative measures to actively eliminate the risk or reduce it as much as possible.

These measures include:

- Evaluation of risks which accompany the medical intervention; implementation of appropriate protective measures.
- Develop systematic procedures for the work flow, as they can help to prevent contamination and injuries.
- Carefully record each patient's medical history to be aware of the individual contagion risk.

Consider all medical devices that have been laid out openly to be as contaminated as used equipment and reprocess them for hygiene. Organise the transport of contaminated devices such that staff, co-workers and third parties are not endangered. All personnel must wear the appropriate protective clothing and gloves.

Medical devices may corrode if they are stored in physiological saline solution. Parts are to be submerged fully in a sterilisation tray, without air bubbles. The use of demineralised water to rinse instruments after disinfection is absolutely necessary to prevent water spots and the formation of crystals. These can disrupt the subsequent sterilisation process.

You are responsible for the sterility of the products you use. For this reason, you must use validated procedures for the cleaning, disinfection, and sterilisation of the equipment, you must ensure that equipment receives regular maintenance, and you must observe all process parameters in every cycle. Please note the shelf life of packaged sterile product (manufacturer's data sheet).

Reprocessing ends with the release for use. Sterilisation indicator and sterilisation date must be recorded on every sterile packing.

Important:

- Products that are delivered in non-sterile condition (e.g. drills and abutments) must be sterilised before they are used on a patient for the first time.
- After use, all reusable medical devices must be reprocessed in accordance with the described procedure.

Automated reprocessing

For automated cleaning to be effective, it must be preceded by manual cleaning. This removes large impurities (blood, tissue and bone fragments). Rinse instruments under flowing, cold water immediately after use, and use a fine nylon brush to clean off the large impurities. Then place the instruments in the cleaning tray of your disinfection and cleaning device.

Ultrasonic cleaning (optional)

If the instruments are very soiled and it is not possible to remove large impurities manually, cleaning in an ultrasonic bath is recommended. Important: The cleaning agent must be compatible with the products. Please observe the application times and concentrations specified by the manufacturer.

Automated cleaning

Only use appropriate cleaning and disinfection equipment for your automated cleaning tasks. This should be validated by the user on the basis of established cleaning processes. Place parts in the cleaning tray in accordance with instructions provided by the manufacturer of the equipment. There are commercially available cleaning and disinfection agents. We recommend: "neodisher MediClean", and "neodisher Z" as the neutralising agent (both from Dr. Weigert, Hamburg). Follow the manufacturer's information on dosage and use. We recommend fully demineralised water to clean instruments and for the final rinsing procedure. The selected cleaning and

disinfection program should run at the optimal temperature for removal of blood (45–55°C).

Example of a cleaning program:

- Pre-rinse with cold water 4 min
- Clean with alkaline cleanser at 45–55°C 10 min
- Neutralise 6 min
- Second rinse 3 min
- Disinfection 5 min
- Drying (max. 130°C) 5 min
- Before the sterilisation process, check the cleaned, dried and disinfected parts for corrosion and damage.

Manual reprocessing

Place the products in a disinfectant solution after use to prevent them from drying out and as a personal protection measure. Remove large impurities (blood, tissue and bone fragments). To do this, take the instruments from the tray and clean them under cold, running water with a fine nylon brush. Never use a metal brush or steel wool for this step!

Ultrasonic cleaning (optional)

If the instruments are very soiled and it is not possible to remove large impurities manually, cleaning in an ultrasonic bath is recommended. Important: The cleaning agent must be compatible with the products. Please observe the application times and concentrations specified by the manufacturer.

Cleaning

Before cleaning the products, rinse them under a flow of cold, demineralised water. Disassemble all products that can be taken apart. A suitable cleaning agent is, for example "neodisher MediClean" (Dr. Weigert, Hamburg). Place the products in a fresh cleaning bath, in accordance with the manufacturer's information. Clean the parts with a nylon brush. Rinse the products several times with demineralised water and check for corrosion or damage.

Disinfection

Place the products that need to be disinfected in a fresh disinfectant bath. The liquid must cover them completely. ID 212 instrument disinfection (Dürr System Hygiene) is a suitable disinfectant, for example.

Rinsing and drying

After disinfection of the products, rinse thoroughly with demineralised water. Residue-free compressed air is to be used to dry the instruments.

Sterilization

Re-assemble the dismantled medical devices before you start the sterilisation procedure. Sort the separately cleaned and disinfected products into the appropriate sterilisation tray. You may also sterilise products individually. Subsequently pack the filled trays and/or the individual products in a non-reusable bag suitable for use in a steam steriliser (single or double bags) and/or in a sterilisation container. Bags for use in steam sterilisation processes must meet the specifications of DIN EN ISO 11607 / ANSI/AAMI ST79 / AAMI TIR12:2010. Two examples are: a non-reusable sterilisation bag (single or double bag) with temperature tolerance of at least 137°C (ca. 278.6 °F) and vapour permeability that allows adequate protection from mechanical damage, or else a sterilisation container, which has to undergo regular maintenance according to specifications of the manufacturer. In the ZERAMEX®T Surgery tray REF T48850, instruments such as drills, thread cutters and depth gauges have dedicated positions where they can be affixed for sterilisation. Sterilisation is achieved in the autoclave at 134 °C for a duration of at least 7 minutes holding time and subsequent vacuum drying. The parts should then be marked with a sterilisation date and placed in dry and dust-free storage.

SURGERY PHASE

WARNING
The drilling depth is up to 1 mm deeper than the corresponding implant.

Depth mark

The diameter is indicated by a colour code on all instruments.

● ● ●

Example **8 mm** implant

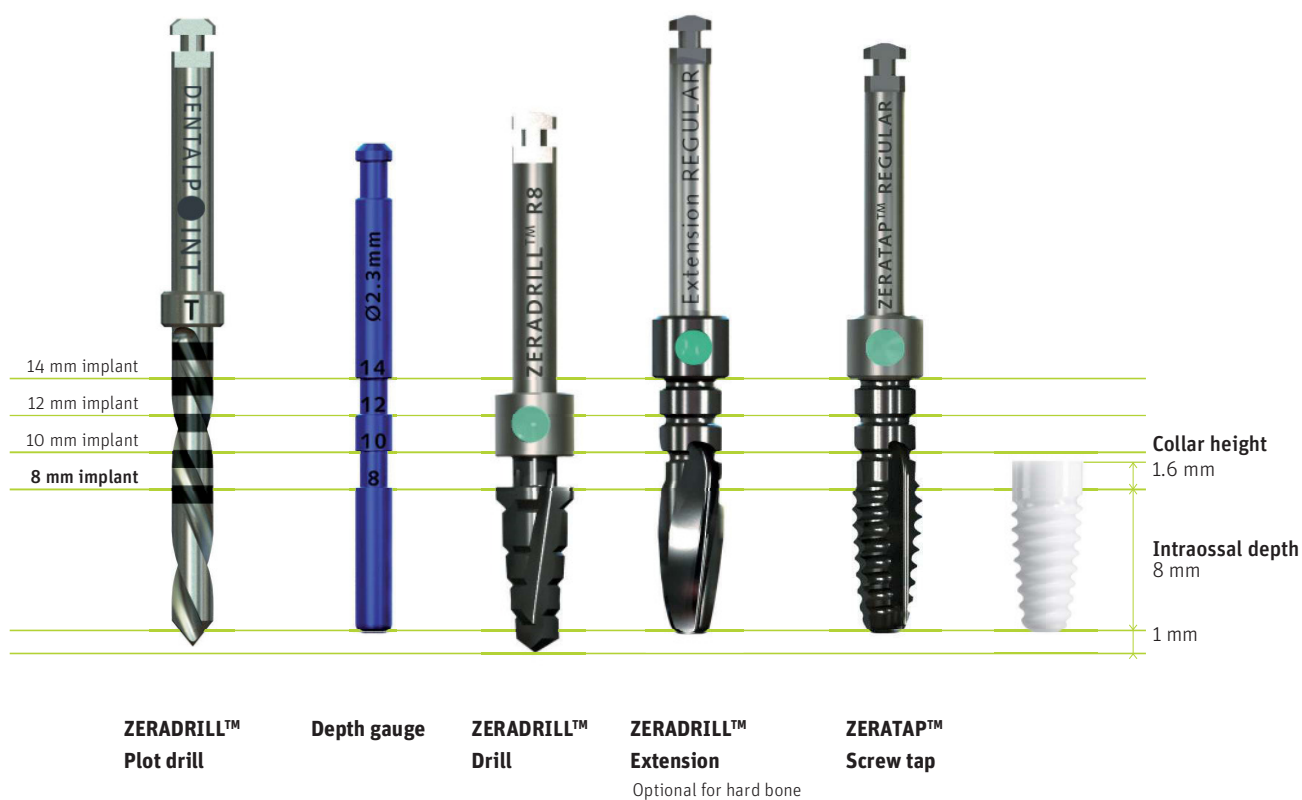

STERILISATION BEFORE OP
OP preparations include steam sterilisation of the surgical tray (surgical instruments) at 134°C for the duration of 18 minutes.

IMPORTANT:
During surgery you should have a container with saline solution nearby. Place the drill and instruments in the saline solution between uses if you use them repeatedly during a treatment session.

Drill Protocol Small

ø 2.3 mm ø 3.5 mm

Rose drill ø 2 mm
max. 800 rpm

ZERADRILL™ Pilot ø 2.3 mm
max. 800 rpm

ZERADRILL™ S8 (SMALL 8 mm)
max. 700 rpm

Optional for hard bone
ZERADRILL™ Extension SMALL
max. 700 rpm

ZERATAP™ SMALL ø 3.5 mm
max. 15 rpm

Example:
ø 3.5 x 8 mm SMALL
Implant

Collar height
1.6 mm

Intraosseal depth
8 mm

1 mm

Small
ø 3.5 mm

ZERALOCKT Sxx

NOTE!

- Do not exceed 35 N cm torque with small ø 3.5 mm implants.
- Indications for use are limited for implant size small (see page 6).

IMPORTANT:
Always pre-cut the thread.

Drill Protocol Regular

∅ 2.0 mm
∅ 3.0 mm
∅ 4.2 mm

Rose drill ∅2 mm
max. 800 rpm

ZERADRILL™ Pilot ∅ 2.3 mm
max. 800 rpm

ZERADRILL™ S8 (SMALL 8 mm)
max. 700 rpm

ZERADRILL™ R8 (REGULAR 8 mm)
max. 600 rpm

Optional for hard bone
ZERADRILL™ Extension REGULAR
max. 600 rpm

ZERATAP™ REGULAR ∅4.2 mm
max. 15 rpm

Collar height
1.6 mm

Intraosseal depth
8 mm

1 mm

Example:
∅ 4.2 x 8 mm SMALL Implant

Regular
∅ 4.2 mm



ZERALOCK Rxx

NOTE!

Do not exceed 45 N cm torque with regular ∅ 4.2 mm implants.

IMPORTANT:

Always pre-cut the thread.

Drill Protocol Wide

∅ 2.3 mm
∅ 3.5 mm
∅ 4.2 mm
∅ 5.5 mm

Collar height
1.6 mm
Intraosseal depth
8 mm
 1 mm

Example:
 ∅ 5.5 x 8 mm SMALL Implant

Rose drill ∅ 2 mm
max. 800 rpm
ZERADRILL™ Pilot ∅ 2.3 mm
max. 800 rpm
ZERADRILL™ S8 (SMALL 8 mm)
max. 700 rpm
ZERADRILL™ R8 (REGULAR 8 mm)
max. 600 rpm
ZERADRILL™ W8 (WIDE 8 mm)
max. 500 rpm
Optional for hard bone
ZERADRILL™ Extension WIDE
max. 500 rpm
ZERATAP™ WIDE ∅5.5 mm
max. 15 rpm

Wide
∅ 5.5 mm



ZERALOCK Wxx

NOTE!

Do not exceed 45 N cm torque with wide ∅ 4.2 mm implants.

IMPORTANT:

Always pre-cut the thread.

SURGERY PHASE

Handling

Materials list:

- Implant passport (Z99905)
- Pickup truck (T38620/T38625)
- Ratchet adapter unit

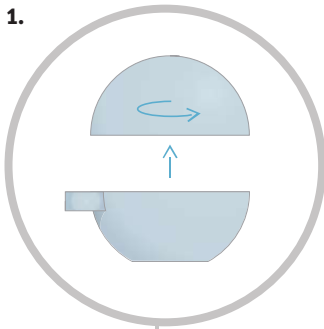

1. Twist to open the container.
Note: Verify the correct dimensions of the implant before you open the container.

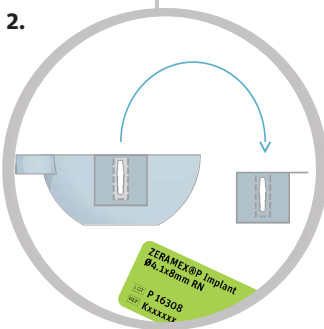

2. Remove the sterile secondary blister pack and the patient labels from the container.

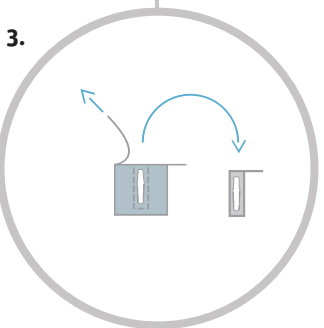

3. Open the secondary blister pack and remove the sterile primary blister.

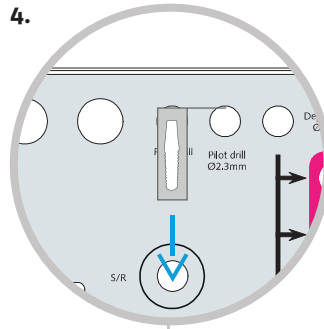

4. Place the sterile primary blister pack in the tray.
Use the correct tray positions corresponding to the diameters used.

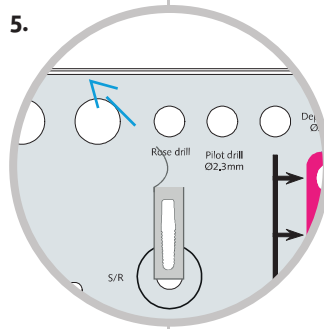

5. Wait until shortly before use to open the seal.

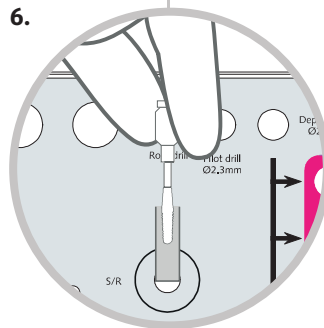

6. Grasp the implant with the help of the pickup found in the ratchet adapter (click into the triangular slot).

DO NOT TURN TOO FAR!
 The maximum torque is 35 N cm for small implants. Maximum torque for regular and wide implants is 45 N cm. Never exceed the maximum torque. Pickup has a breaking point of approx. 50 N cm. Maximum torque: 15 rpm

Insertion of the implant and closure

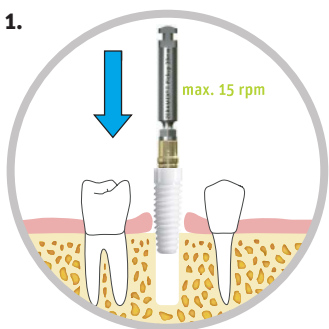

1. Slowly screw the implant into the pre-cut drill hole.
Important: Never use the rescue pickup for insertion.

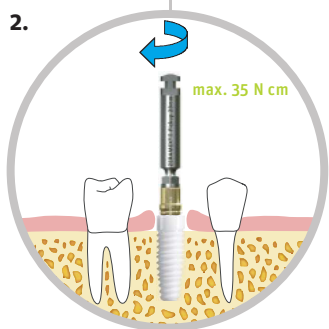

2. Twist the implant into position with the ratchet. Recommended torque: 20–30 N cm
Note! Due to the conical design, torque does not build up until the last two turns.

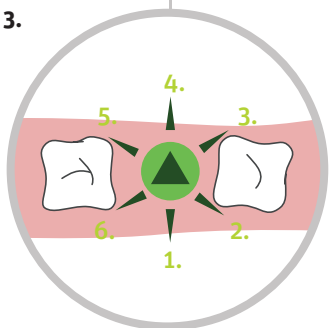

3. Optional for extreme angles:
 For angled abutments, the direction of the triangle can be adjusted with the alignment aid (T38626)
 ▲ = 6 possible positions of the abutment

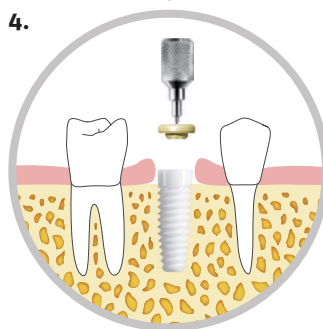

4. Close the implant with a healing cap. Use the insertion/extraction tool for this.

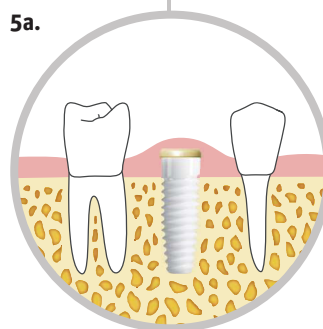

5a. Option 1: Closed healing period (recommended)

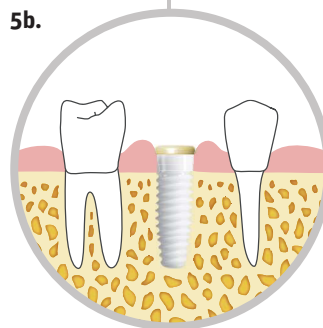

5b. Option 2: Open healing period; care for tight fitting gingiva.

PROVISIONAL RESTORATION

Soft tissue management with ZERALOCK™ gingiva former

Materials list:

- Gingiva former (T35304/T36304/T37304)
- Alignment aid (T38626), pickup (T38620/T38625)
- Possibly an insertion and extraction aid (T38635)

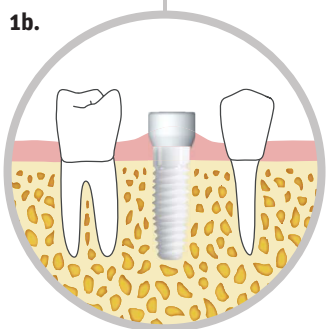
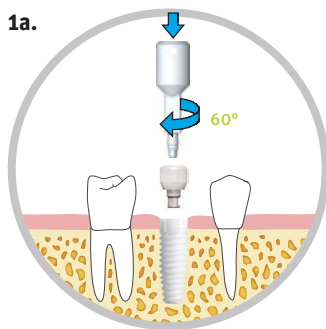

1a/b. Insertion: Attach the gingiva former to the pickup or to the alignment aid. Feel for the triangle with light pressure and insert just to the shoulder platform in the implant. Lock into the implant with a 60 degree turn clockwise.

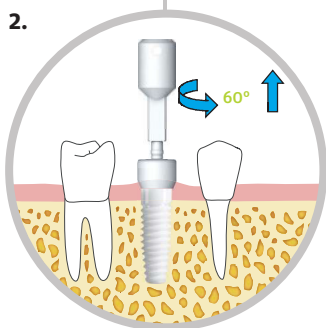

2. Removal: To loosen the gingiva former, insert the pickup or the alignment aid and turn 60 degrees counterclockwise.

Tip: If the gingiva former sticks because of dried blood and wound secretions, you can use the insertion/extraction tool to withdraw it after softening.

DO NOT TURN TOO FAR!

There is no need to exert force when inserting the gingiva former. After insertion, cautiously turn 60 degrees to the stopping point.

INDIRECT IMPRESSION TAKING

Closed impression tray

Materials list:

- Transfer closed tray (T35312/T36312)
- Implant replica (T35320/T36320/T37320)

In practice:

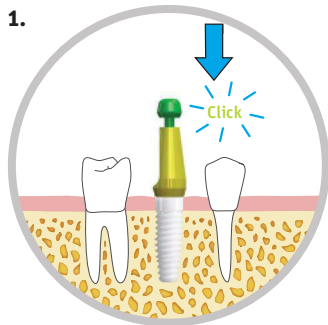

1. Clicking into position: Feel for the triangle with light pressure and insert the transfer with its **extended locking pin** just as far into the implant as the stopping point (click).

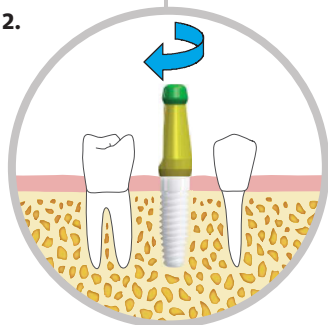

2. Screw securely: Screw the locking pin in by hand and check that it sits securely in the implant. Tip: You can use the abutment holder (T38644) to screw this securely.

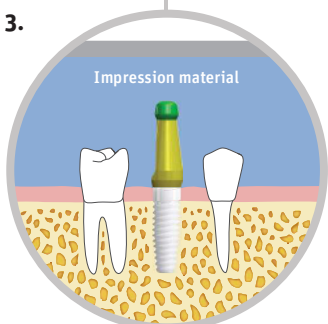

3. Impression taking: Make an impression with a closed impression tray and extract it. Unscrew the locking pin, extract the transfer from the implant, and deliver it to the dental technician with the impression.

In the lab:

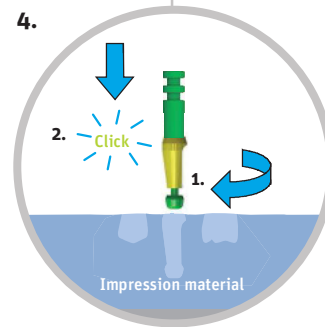

4. Connecting: Feel for the triangle with light pressure and insert the transfer with its **extended locking pin** just as far into the implant as the stopping point (click). Screw the locking pin all the way in. Make sure that the diameter of the replica is correct.

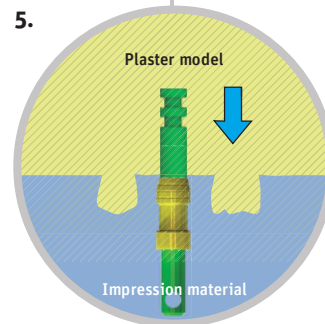

5. Re-setting and model fabrication: Take the transfer holding the implant replica and reset it in the impression, making sure that it sits securely. Make the master model.

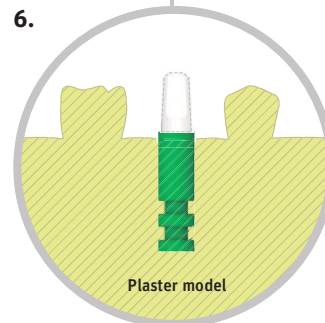

6. Select a secondary part in accordance with the needs of the prosthesis and the procedure used. You can choose between straight and angled abutments, a CAD/CAM base, and LOCATOR®. (More information on page 23.)

INDIRECT IMPRESSION TAKING

Open impression tray

In practice:

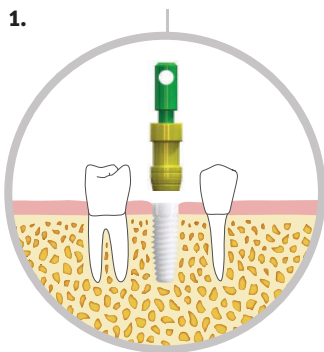

1. Attaching components: Position the locking pin securely at the stopping point in the transfer (triangle). Attach the combined components to the implant.

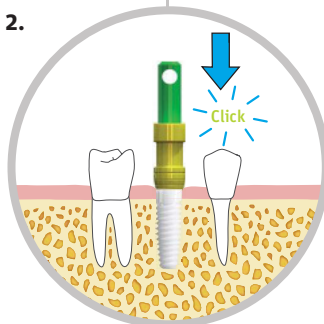

2. Click into position: Feel for the triangle with light pressure on the locking pin and insert it to the stopping point (click). Verify that it is in correct position.

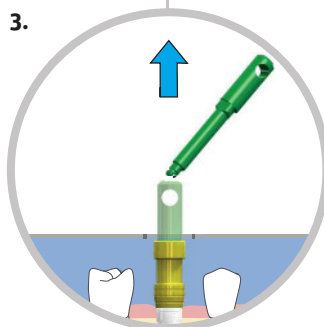

3. Impression taking: Make an impression with an open impression tray. Withdraw the locking pin without turning it and extract the impression.

Materials list:

- Implant transfer open tray (T35310/T36310)
- Implant replica (T35320/T36320/T37320)

In the lab:

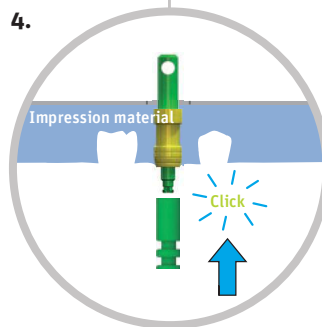

4. Connecting: Position the locking pin correctly in the transfer (triangle). Feel for the triangle with light pressure on the implant replica and insert into the locking pin to the stopping point (click).

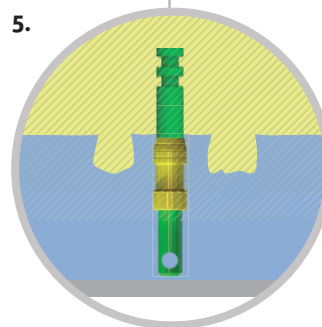

5. Create model: Make sure that the transfer with attached implant replica is seated securely. Make the master model.

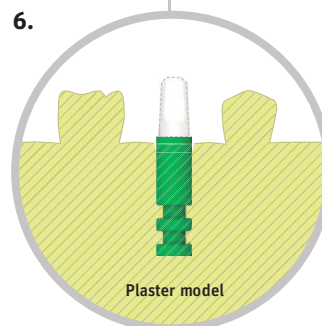

6. Select a secondary part in accordance with the needs of the prosthesis and the procedure used. You can choose between straight and angled abutments, a CAD/CAM base, and LOCATOR®. (More information on page 23.)

Making the supraconstruction in the lab

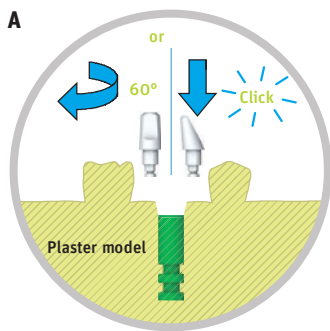

A. Use the planning set to select an abutment. Abutment, straight: turn 60 degrees clockwise. Abutment, angled: Click into position.

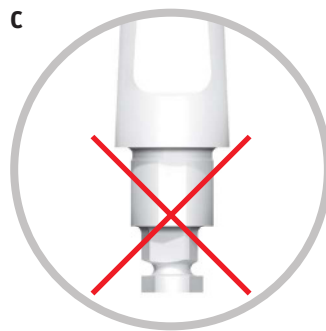

C WARNING: Never subject Abutment Hex to grit blasting or processing. Do not treat abutments with heat or fire. Avoid spot heating by flame or laser.

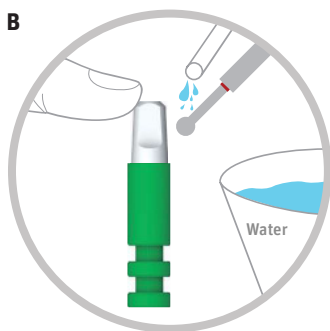

B. If necessary, grind the abutment separately. Only use a diamond abrasive suited for use on zirconium oxide, and use light pressure with good, continuous cooling. Use a high rotation speed. Note: Local overheating leads to micro-cracks and destruction of the abutment.

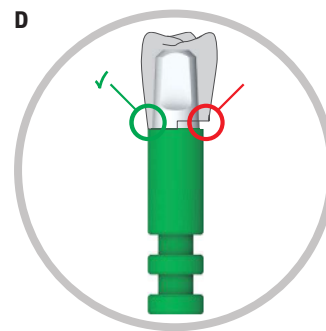

D. The supraconstruction must sit on the platform with a perfect match. Do not forget the cement gap during fabrication.

Important facts in the lab at a glance:

- Consider the anatomic situation, and do not create oversized crowns or attachments to natural teeth.
- When grinding the abutment, the replica can serve as a holder, building pressure against it with a finger to reduce vibrations.
- For angled abutments and complex restorations the keys have to be made individually.
- Free end situations, also called cantilevers, must not be created with a pillar as the support.
- Use diamond abrasives with fine grain (less than 50 μm) exclusively. Use high rotation speed and good cooling.

CEMENTING

NOTE!

You must never apply cement directly to the implant!
Always apply generously to the ABUTMENT POST.

Cement the implant with ZERAGLU™

Materials list:

- ZERAGLU™ Cement (T48910)
- ZERAGLU™ Mixer needle (T116587)
- Abutment and abutment holder

Note:

The implant interior and the abutment post do not require any pre-treatment except for cleaning and drying.

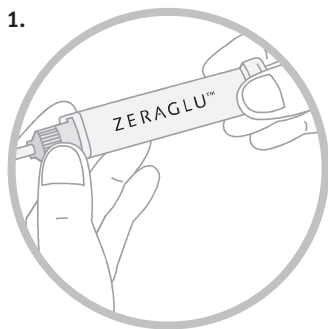

1.

1. Remember to remove ZERAGLU™ cement from the refrigerator early enough and allow it to reach room temperature. Open the tube and place the mixer needle on it.

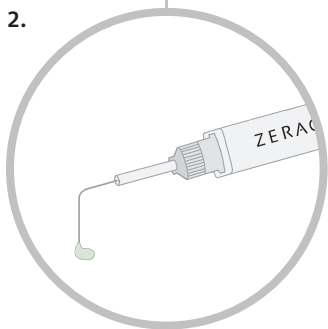

2.

2. Press the glue syringe until green cement emerges from the tip, and discard the first drops.

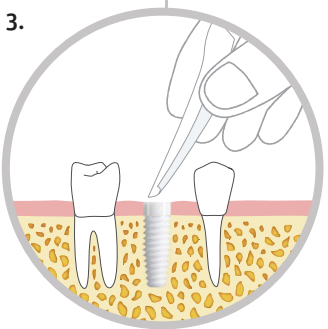

3.

3. Clean the interior triangle and abutment post with ethanol to remove impurities and oiliness. Use paper points to keep the interior of the implant dry.
Optional: Place a string around the implant.

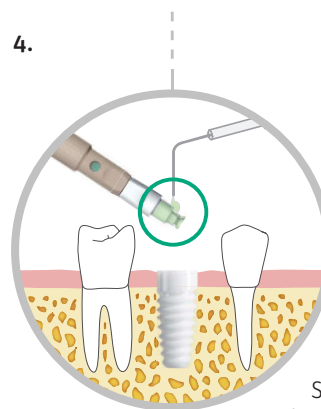

4.

4. Apply a small amount of cement* to the abutment post and use the tip of a needle or a disposable brush to spread it.

Straight abutments, Locator®:

Straight abutments: Insert the abutment into the implant and turn 60 degrees to lock the implant into place. Turn the abutment holder clockwise to separate it from the abutment. **Angled abutments, CAD/CAM base:** Insert the abutment until there is a click (Do not turn it!). If an individualised key is used, wait about 10 minutes hardening time before removal.

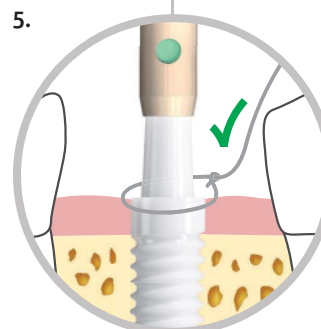

5.

5. **Correct:** The abutment must sit precisely on the shoulder of the implant! ZERAGLU™ needs 10 minutes to harden completely.* After that you can remove the string and all excess cement.

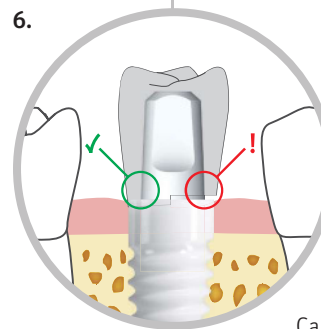

6.

6. Cementing a crown: The crown must sit precisely on the shoulder of the implant. Carefully remove all excess cement.

* ZERAGLU™ only hardens under airtight conditions, and this rules out cement infection. A small excess of cement should be visible around the circumference of the implant shoulder to guarantee a permanent and bacteria-free cementation. Remove this when the cement has hardened.

DIRECT IMPRESSION TAKING

Direct impression taking

As an alternative to indirect impression taking, the possibility of direct impression taking is also available to you.

Materials list:

- Abutment planning set, optional (T18350)
- ZERAGLU™ Cement (T48910)
- ZERAGLU™ Mixer needle (T116587)
- Abutment and abutment holder

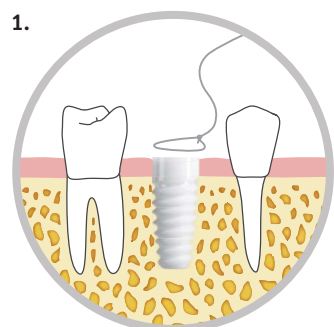

1.

1. Expose the implant and select an appropriate abutment with the help of the planning set. Optional: Loop a string around the implant for the safe removal of excess cement.

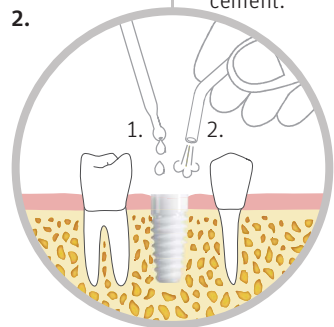

2.

2. Clean the interior triangle with ethanol (1) and dry ready for cementing (2). Use paper points to keep the interior of the implant connector dry. (For ZERAGLU™ preparation, see page 24.)

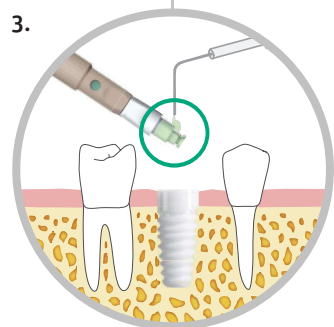

3.

3. Place the abutment in the abutment holder. Apply a small amount of cement to the abutment post and spread it with the tip of a needle or a disposable brush.

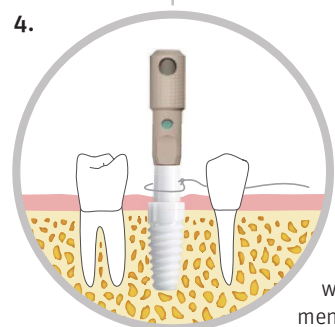

4.

4. Straight abutments, Locator®: Straight abutments: Insert the abutment into the implant and turn 60 degrees to lock the implant into place. Turn the abutment holder clockwise to separate it from the abutment. **Angled abutments, CAD/CAM base:** Insert the abutment until there is a click (Do not turn it!). If an individualised key is used, wait about 10 minutes hardening time before removal.

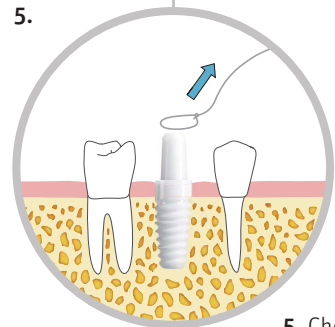

5.

5. Check abutments for the correct positioning and allow about 10 minutes for hardening. Remove string and extra cement.

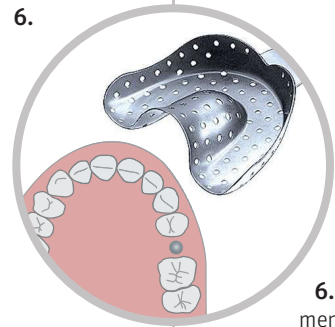

6.

6. If it is necessary, grind the abutment separately.** Be sure to provide continuous cooling and work with appropriate diamond instruments (fine grain) and light pressure.** Take an impression and proceed as for a natural tooth.

** For subsequent polishing use only special abrasives. Zirconium oxide can reach spot heat measurements of 600°C. To avoid these local areas of overheating, use a turbine with water cooling and work with low surface pressure.

CAD/CAM Base Post

The CAD/CAM base post enables the fabrication of fully customised ceramic abutments for ZERAMEX®T implants. Using the CAD/CAM base post with an individually fabricated supraconstruction affords optimal anatomical and aesthetic crown margins. CAD/CAM base posts are manufactured with the utmost precision, and they ensure custom-fitted connection to the implant.

Advantages at a glance:

- Customised emergence profiles for optimal aesthetic results
- Metal-free and biocompatible
- Precise connection with the implant
- Flexible fabrication process enables CAD/CAM, pressed ceramic or veneering
- Compatible with all scanning systems
- Optimal accommodation of divergent implants

Treatment tips::

- The CAD/CAM base post can be processed at the head end with fine diamond abrasion (red ring, small 50 µm) and with good cooling.
- **NOTE!** Do not grit blast or further process the implant connecting part or the shoulder of a CAD/CAM base post!
- The CAD/CAM base post must sit on the implant in its entirety.
- Thermal expansion coefficient ZrO₂-ATZ-HIP®:
10 x 10⁻⁶ / K



IMPORTANT:

The CAD/CAM base post comes with a separate ZERALOCK™ PEEK lock ring. The ring can only be mounted after the firing process (max. temperature PEEK 200°C) if layer, firing or press techniques are used.

Regular
ø 4.2 mm



Wide
ø 5.5 mm



Dimensions in mm:

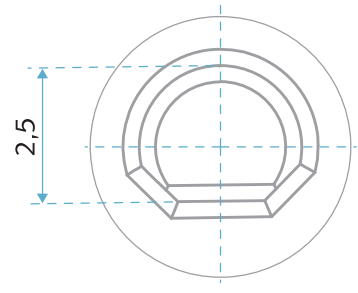
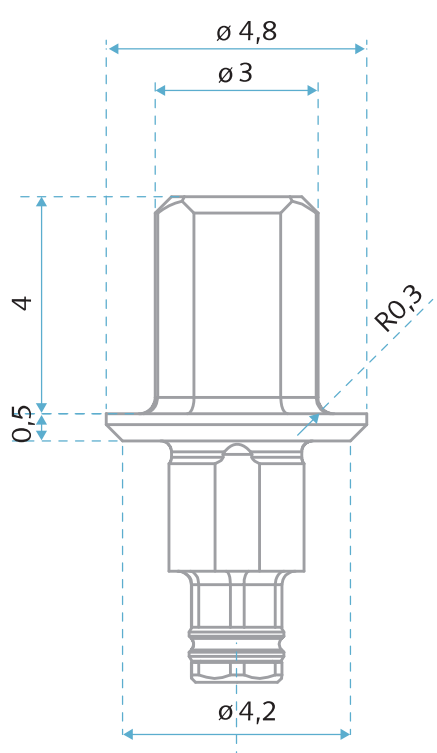

T16330

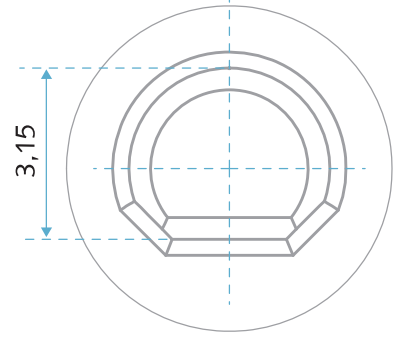
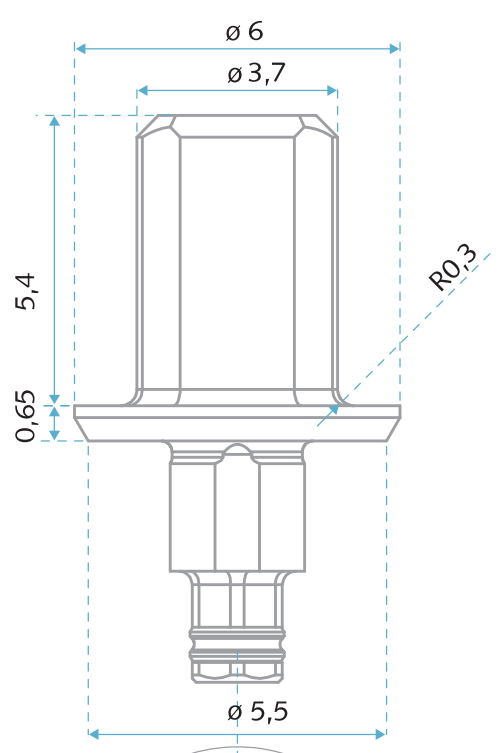

T17330

Fabrication of individual abutments using CAD/CAM technology

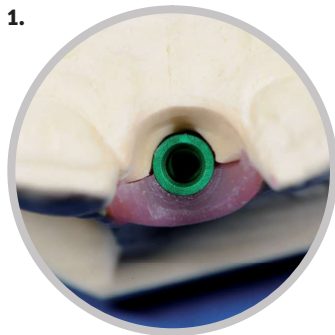

1. Produce a model with the implant replica.

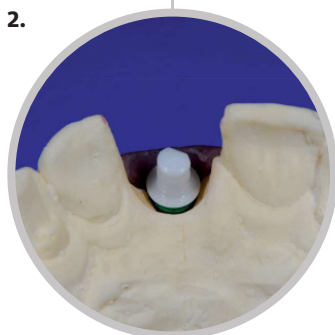

2. Insert the CAD/CAM base post in the implant replica.

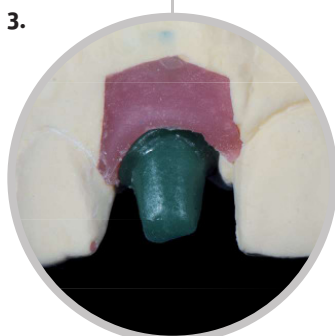

3. Scan according to instructions provided by the system provider.

Producing an individual abutment by CAD/CAM requires more scanning procedures (e.g. squash bites, gingival mask, etc.).

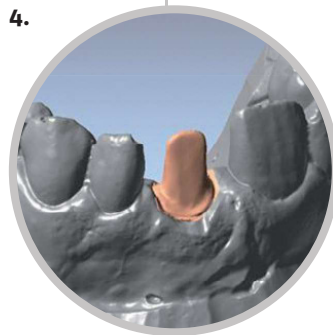

4. CAD software is used to form the mesostructure of the CAD/CAM base post. Individually fabricated abutments for cement-retained full ceramic crowns require specific designs (a ledge, chamfer, etc.). The minimum wall thicknesses of a crown framework must be in accordance with the recommendations of the manufacturer of the material and must not be thinner than the specified minimum wall thickness. The CAD/CAM base post and the individually fabricated supraconstruction must be cemented before fabrication of the crown.

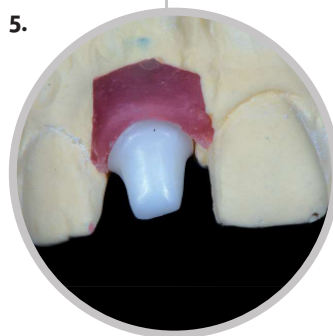

5. Before cementing, the CAD/CAM base post and the customised structure must be cleaned thoroughly with ethanol. The pieces must be cleansed of all dust and grease residue.

For cementing of the CAD/CAM base post, we recommend use of the following:

- ZERAGLU™, Dentalpoint AG

Mix the glue in accordance with the manufacturer's instructions and apply a thin layer to the cementation surface of the CAD/CAM base post. Then pull the individual structure over the CAD/CAM base post and down until it reaches the stop point. Allow the cement to harden according to the manufacturer's information (usually 5–10 minutes).



6. Mount the ZERALOCK™ PEEK lock ring.

Clean the edges thoroughly to remove all excess cement.

Direct fabrication of a crown

Layer technique/Firing

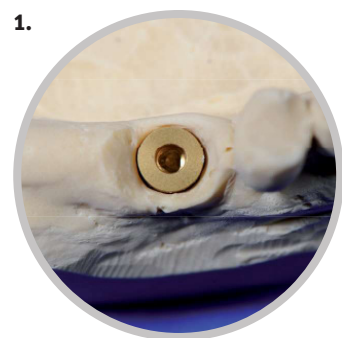

1. Produce a model with the implant replica.

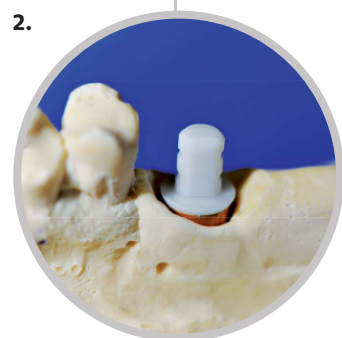

2. Insert CAD/CAM base post in the model.

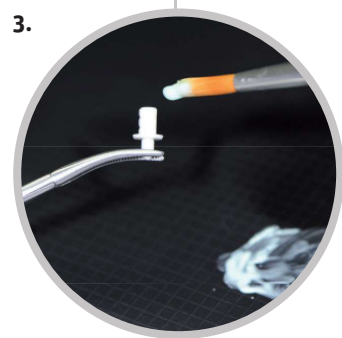

3. Apply the CAD/CAM liner to the base post.

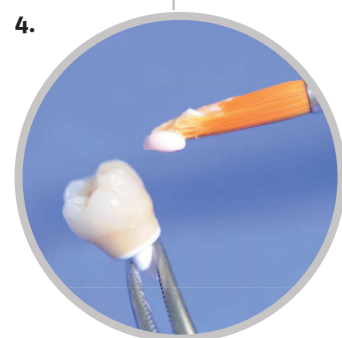

4. Produce the crown using a layer technique.

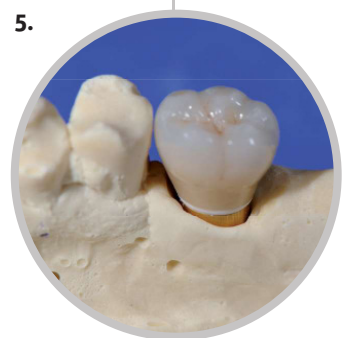

5. Check it on the model.



6. ZERALOCK™ PEEK
Mount the lock ring.

IMPORTANT:

It is extremely important to respect the minimum layer thickness of the material used for the crown in accordance with the manufacturer's specifications!

Direct fabrication of a crown Press technique

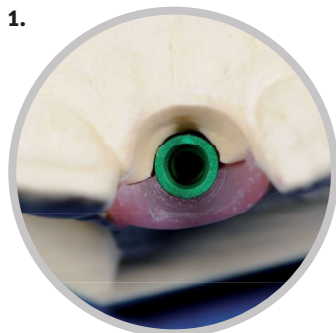

1. Produce a model.

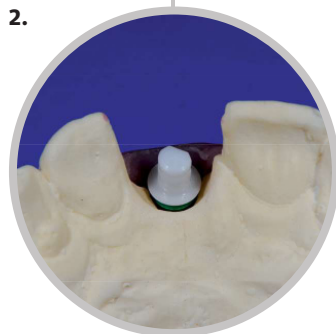

2. Insert CAD/CAM Base Post in the model.

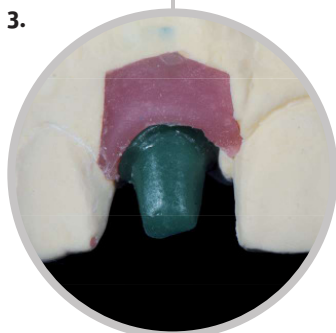

3. Apply and embed wax in the desired form.



4. Press.



5. ZERALOCK™ PEEK
Mount the lock ring.

Straightening divergent pillars

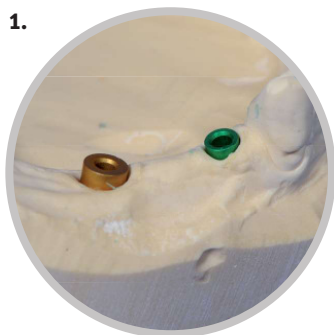

1.

1. Make a model and insert the CAD/CAM base posts.

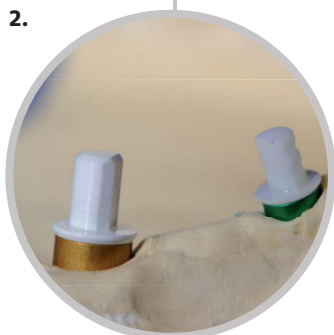

2.

2. Straighten the pillars using the CAD/CAM or press technique

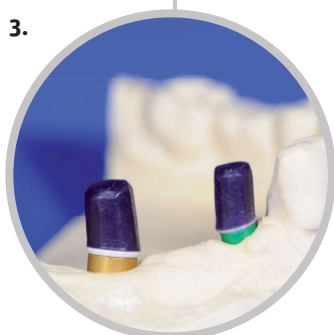

3.

3. Before cementing, the CAD/CAM base post and the customised structure must be cleaned thoroughly with ethanol. The pieces must be cleansed of all dust and grease residue.

For cementing of the CAD/CAM base post, we recommend use of the following:
ZERAGLU™, Dentalpoint AG

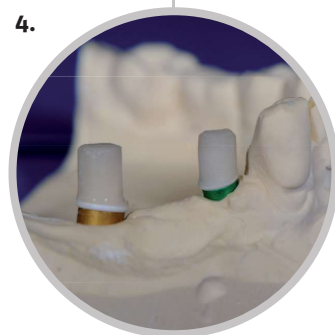

4.

4. Build a bridge over the pillars that are now parallel. Cement the bridge only once inside the patient's mouth!



5.

5. Mount the ZERALOCK™ PEEK lock ring.



ZERAMEX[®] 

Product range

PRODUCT RANGE











ZERAMEX®T ZERALOCK™ Implants

 ZERAMEX®T ZERALOCK™ Implant small ø 3.5 x 8 mm T15308	 ZERAMEX®T ZERALOCK™ Implant small ø 3.5 x 10 mm T15310	 ZERAMEX®T ZERALOCK™ Implant small ø 3.5 x 12 mm T15312	
 ZERAMEX®T ZERALOCK™ Implant small ø 4.2 x 8 mm T16308	 ZERAMEX®T ZERALOCK™ Implant regular ø 4.2 x 10 mm T16310	 ZERAMEX®T ZERALOCK™ Implant regular ø 4.2 x 12 mm T16312	 ZERAMEX®T ZERALOCK™ Implant regular ø 4.2 x 14 mm T16314
 ZERAMEX®T ZERALOCK™ Implant wide ø 5.5 x 8 mm T17308	 ZERAMEX®T ZERALOCK™ Implant wide ø 5.5 x 10 mm T17310	 ZERAMEX®T ZERALOCK™ Implant wide ø 5.5 x 12 mm T17312	





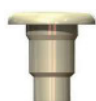





ZERAMEX® ZERALOCK™ Abutments

 ZERAMEX®T ZERALOCK™ Abutment small straight T15300	 ZERAMEX®T ZERALOCK™ Abutment small angled 15° T15315	 ZERAMEX® ZERALOCK™ Abutment regular straight T16300	 ZERAMEX® ZERALOCK™ Abutment regular angled 15° T16315	 ZERAMEX®T ZERALOCK™ Abutment wide straight T17300
 ZERAMEX® ZERALOCK™ LOCATOR® regular/wide 2mm P16202	 ZERAMEX® ZERALOCK™ LOCATOR® regular/wide 3mm P16203	 ZERAMEX® ZERALOCK™ LOCATOR® regular/wide 5mm P16205	 ZERAMEX®T ZERALOCK™ CAD/CAM Base regular ø 4.2 T16330	 ZERAMEX®T ZERALOCK™ CAD/CAM Base wide ø 5.5 T17330
 ZERAMEX®T LOCATOR® small 2mm T15202	 ZERAMEX®T LOCATOR® small 3mm T15203	 ZERAMEX®T LOCATOR® regular/wide 2mm T16202	 ZERAMEX®T LOCATOR® regular/wide 3mm T16203	 ZERAMEX®T ZERALOCK™ Abutment planning set T18350

ZERAMEX[®] ZERALOCK[™] Prosthetics

































 <p>ZERAMEX[®] ZERALOCK[™] Gingiva former small \varnothing 3.5 x 4 mm T35304</p>	 <p>ZERAMEX[®] ZERALOCK[™] Transfer open tray small T35310</p>	 <p>ZERAMEX[®] ZERALOCK[™] Transfer closed tray small T35312</p>	 <p>ZERAMEX[®] ZERALOCK[™] Implant replica small \varnothing 3.5 mm T35320</p>	 <p>ZERAMEX[®] Healing cap small \varnothing 3.5 mm T35400</p>
 <p>ZERAMEX[®] ZERALOCK[™] Gingiva former regular \varnothing 4.2 x 4 mm T36304</p>	 <p>ZERAMEX[®] ZERALOCK[™] Transfer open tray regular/wide T36310</p>	 <p>ZERAMEX[®] ZERALOCK[™] Transfer closed tray regular/wide T36312</p>	 <p>ZERAMEX[®] ZERALOCK[™] Implant replica regular \varnothing 4.2 mm T36320</p>	 <p>ZERAMEX[®] Healing cap regular \varnothing 4.2 mm T36400</p>
 <p>ZERAMEX[®] ZERALOCK[™] Gingiva former wide \varnothing 5.5 x 4 mm T37304</p>	 <p>ZERAMEX[®] ZERALOCK[™] Implant replica wide \varnothing 5.5 mm T37320</p>	 <p>ZERAMEX[®] Healing cap wide \varnothing 5.5 mm T37400</p>		

ZERAMEX[®] ZERALOCK[™] Locator[®]

 <p>LOCATOR[®] Processing denture cap (0-10°, clear, pink, blue), 2 pcs T38219</p>	 <p>LOCATOR[®] Processing denture cap (0-20°, green, orange, red), 2 pcs T38220</p>	 <p>LOCATOR[®] Blockout spacer, 20 pcs T38222</p>	 <p>LOCATOR[®] Impression coping, 4 pcs T38224</p>	 <p>LOCATOR[®] Replica \varnothing 4 mm, 4 pcs T38226</p>
 <p>LOCATOR[®] Replica \varnothing 5 mm, 4 pcs T38227</p>	 <p>LOCATOR[®] Core tool T38228</p>	 <p>LOCATOR[®] Replacement clear, 4 pcs T38230</p>	 <p>LOCATOR[®] Replacement pink, 4 pcs T38231</p>	 <p>LOCATOR[®] Replacement blue, 4 pcs T38232</p>
 <p>LOCATOR[®] Replacement green, 4 pcs T38233</p>	 <p>LOCATOR[®] Replacement orange, 4 pcs T38234</p>	 <p>LOCATOR[®] Replacement red, 4 pcs T38235</p>		

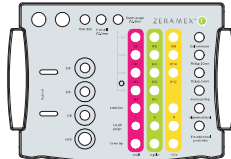
PRODUCT RANGE

ZERAMEX®T Tools

				
Rose drill \varnothing 2 mm T35601	ZERADRILL™ Pilot \varnothing 2.3 mm T35602	ZERADRILL™ S8 (SMALL 8 mm) T35608	ZERADRILL™ S10 (SMALL 10 mm) T35610	ZERADRILL™ S12 (SMALL 12 mm) T35612
				
ZERADRILL™ S14 (SMALL 14 mm) T35614	ZERATAP™ SMALL \varnothing 3.5 mm T35620	ZERADRILL™ Extension SMALL T35622	ZERADRILL™ R8 (REGULAR 8 mm) T36608	ZERADRILL™ R10 (REGULAR 10 mm) T36610
				
ZERADRILL™ R12 (REGULAR 12 mm) T36612	ZERADRILL™ R14 (REGULAR 14 mm) T36614	ZERATAP™ REGULAR \varnothing 4.2 mm T36620	ZERADRILL™ Extension REGULAR T36622	ZERADRILL™ W8 (WIDE 8 mm) T37608
				
ZERADRILL™ W10 (WIDE 10 mm) T37610	ZERADRILL™ W12 (WIDE 12 mm) T37612	ZERATAP™ WIDE \varnothing 5.5 mm T37620	ZERADRILL™ Extension WIDE T37622	ZERAMEX®T Pickup 20 mm T38620
				
ZERAMEX®T Rescue pickup T38622	ZERAMEX®T Pickup 25 mm T38625	ZERAMEX®T Alignment aid T38626	Drill extension T38630	Insertion and extraction aid, prosthetic parts T38635
				
ZERALOCK™ Abutment holder set T38644	ZERAMEX®T depth gauge, 4 pcs. T38650	ZERAMEX®T parallelling pin \varnothing 2.3 mm, 4 pcs T38652	ZERAMEX®T Surgery tray T48950	
			ZERAMEX®T Surgery tray, fully equipped, with standard ratchet T48954	
Surgical ratchet, standard, 0-45 N cm, incl. adapter unit T48935	ZERAGLU™ Mixer needle, 5 pcs T116587	ZERAGLU™ Cement T48910		

ZERAMEX® ZERALOCK™ Locator®

 <p>LOCATOR® Processing denture cap (0-10°, clear, pink, blue), 2 pcs T38219</p>	 <p>LOCATOR® Processing denture cap (0-20°, green, orange, red), 2 pcs T38220</p>	 <p>LOCATOR® Blockout spacer, 20 pcs T38222</p>	 <p>LOCATOR® Impression coping, 4 pcs T38224</p>	 <p>LOCATOR® Replica ø 4 mm, 4 pcs T38226</p>
 <p>LOCATOR® Replica ø 5 mm, 4 pcs T38227</p>	 <p>LOCATOR® Core tool T38228</p>	 <p>LOCATOR® Replacement clear, 4 pcs T38230</p>	 <p>LOCATOR® Replacement pink, 4 pcs T38231</p>	 <p>LOCATOR® Replacement blue, 4 pcs T38232</p>
 <p>LOCATOR® Replacement green, 4 pcs T38233</p>	 <p>LOCATOR® Replacement orange, 4 pcs T38234</p>	 <p>LOCATOR® Replacement red, 4 pcs T38235</p>		

ZERAMEX®P Promotion

 <p>ZERAMEX®T Globe implant model T99801</p>	 <p>ZERAMEX® Holder patient flyer Z99803</p>	 <p>ZERAMEX®T Model, 40 cm mit LED illumination T99804</p>	 <p>ZERAMEX® Poster 80 x 60 cm Z99805</p>	
---	---	---	--	--

ZERAMEX® P Documents

 <p>ZERAMEX® Brochure DE Z99901</p>	 <p>ZERAMEX® Patient flyer DE, 25 pcs Z99902</p>	 <p>ZERAMEX® Patient brochure DE, 25 pcs Z99903</p>	 <p>ZERAMEX®T User guide, product line DE T99903</p>	 <p>ZERAMEX® Implant passport DE, 10 pcs Z99905</p>
--	---	--	---	--

General information

Guarantee

Dentalpoint AG guarantees its implants and abutments against material damage for a duration of 10 years.

Delivery and packaging

Dentalpoint AG delivers in accordance with its general terms and conditions. The intact, double sterile packaging protects the implant from external conditions and ensures sterile storage up to the expiry date printed on the packaging.

ZERAMEX®T implants and components must be stored in the original packaging at room temperature, and they must be kept dry and protected from sunlight.

Do not open the packaging until shortly before use in surgery. We recommend complete clinical, radiological and statistical documentation.

Traceability of the implants is ensured by the inside label (patient label).

Limitation of liability

ZERAMEX®T implants are part of a complete system, and they may only be used with the appropriate components.

Dentalpoint AG excludes all liability for damages incurred by incorrect use or by the use of components that are not the original parts. Dentalpoint AG terms and conditions are valid in all other instances.

Continued education

For information on courses and possibilities for continued education offered for ZERAMEX®T, please contact us at www.zeramex.com.

Material properties

All of the company's implants and abutments are manufactured from hot, post-compacted zirconium oxide TZP-A-BIO-HIP® (HIP = hot isostatic postcompaction) or ATZ-HIP® produced by Metoxit AG in Thayngen (CH). To ensure their quality and durability, these implants and abutments are cut from the complete and hard blank with diamond abrasion tools and then polished into the final form. This ensures that there are no product deformations such as they would occur if processed before firing. This makes it possible to have a reproducible, precisely fabricated cementing gap of only 10 µm in the implant.

ZERAFIL™ Surface of the Implants

- micro-structured
- grit blasted and thermally etched
- hydrophilic

ZrO₂-TZP-A-BIO-HIP®

Zirconium oxide, TZP
(tetragonal zirconia polycrystal)

Composition:

ZrO₂ 95%, Y₂O₃ 5%, Al₂O₃ 0.25%
Flexural strength: 1200 MPa

ZrO₂-ATZ-HIP®

Zirconium oxide, ATZ
(alumina-toughened zirconia)

Composition:

















ZrO₂ 76%, Al₂O₃ 20%, Y₂O₃ 4%
Flexural strength: 2000 MPa

PEEK Classix

Polyetheretherketone USP Class VI

Aluminium

Aluminium AW70-75

 0050	 Note (observe accompanying documents)
 Order number	 Expiry date:
 Batch ID	 Follow the instructions for use
 Do not reuse	 Manufacturing date:
 Steam sterilized	 Manufacturer
 Unsterile	 Do not use if packaging is damaged
 Keep away from sunlight	 Keep dry
 Implant small dia. 3,5mm	 Implant wide dia. 5,5mm
 Implant regular dia. 4,2mm	

